

# APPLICATION GUIDE

# ICM 500

## Digital Timer

TUDR Model

Multi-mode, programmable time delay

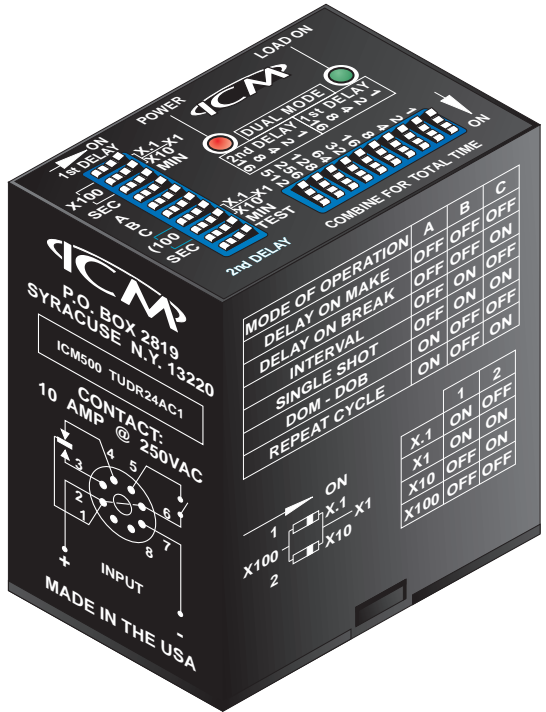

# ICM CONTROLS

# Product Identification

---

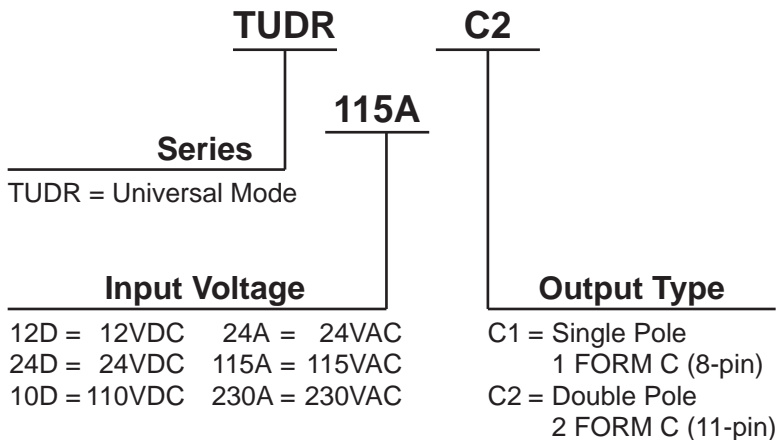

## CAUTION

Installation should be performed by trained technicians only. Adhere to all local and national electric codes. Disconnect all power to the system before making connections.

# Selecting the Mode of Operation

## SINGLE TIME DELAYS

Delay on Make .....	2
Delay on Break.....	3
Interval .....	4
Single Shot.....	5
Programming for Single Time Delays .....	6

## DUAL TIME DELAYS

Delay on Make/Delay on Break.....	8
Repeat Cycle.....	9
Programming for Dual Time Delays .....	10
Testing the Unit.....	12
Ordering Information .....	12
Specifications .....	13

# Delay on Make

## Mode of Operation

When power is applied to the input, the time delay begins. After the time delay is complete, the contacts transfer and remain transferred as long as power is applied. The control is reset by removing power during or after the time delay period.

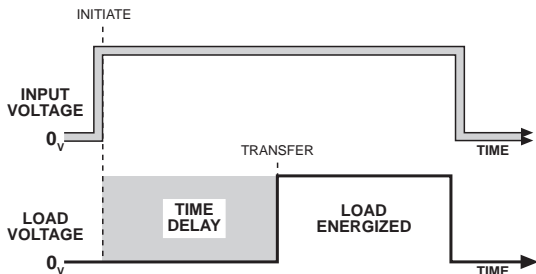

## Connection Diagrams

Single Pole Output  
1 FORM C

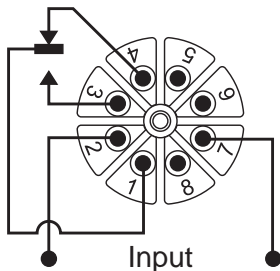

Double Pole Output  
2 FORM C

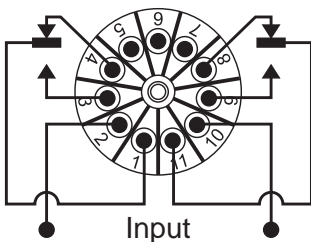

Mode Switch, Delay on Make  
(See programming instructions on P.6)

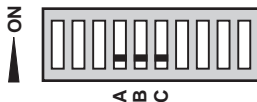

# Delay on Break

## Mode of Operation

Power must be applied before and during the time delay period. When the initiate contact closes, the contacts transfer and remain transferred as long as the initiate contact is closed. The time delay begins when the initiate contact opens. At the end of the time delay period, the contacts are returned to the off state. If the initiate contact recloses during the time delay period, the contacts remain transferred and the time delay is reset to zero. Removal of input power during the delay returns the contacts to the off state and resets the time delay to zero. A one second interrogation delay prevents nuisance trips due to initiate switch bounce or tampering.

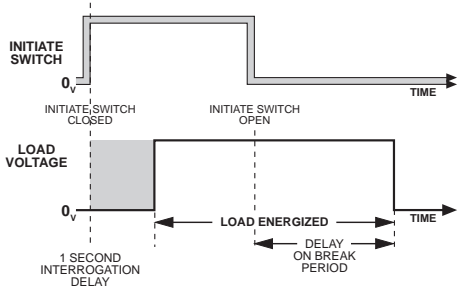

## Connection Diagrams

Single Pole Output  
1 FORM C

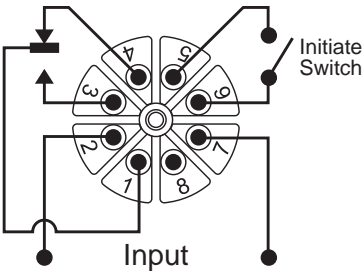

Double Pole Output  
2 FORM C

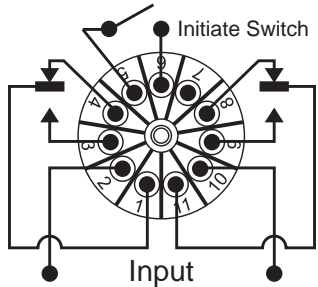

Mode Switch,  
Delay on Break  
(See programming  
instructions on P.6)



# Interval

## Mode of Operation

When power is applied to the input, the contacts will transfer. After the time delay is complete, the contacts will return to their off state. The contacts will remain in the off state indefinitely unless power is reset.

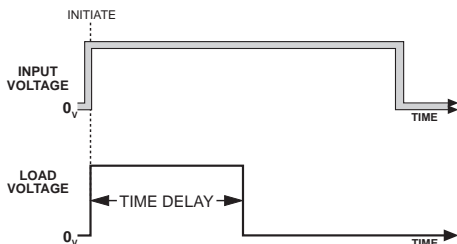

## Connection Diagrams

Single Pole Output  
1 FORM C

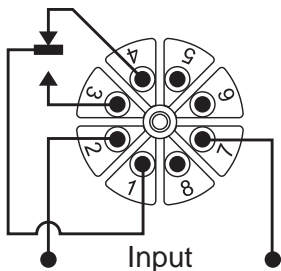

Double Pole Output  
2 FORM C

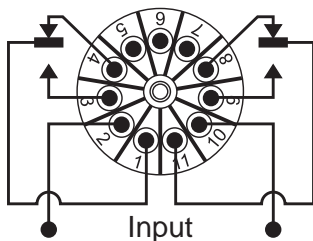

Mode Switch,  
Interval  
(See programming  
instructions on P.6)



# Single Shot

## Mode of Operation

Power must be applied to the input terminals before and during the delay period. When the initiate contact closes, the output contacts transfer immediately and the time delay begins. The output contacts return to their original position when the delay period is complete.

Note: The initial contact closure can be momentary or maintained. To reset the timer during the delay period, remove the input power.

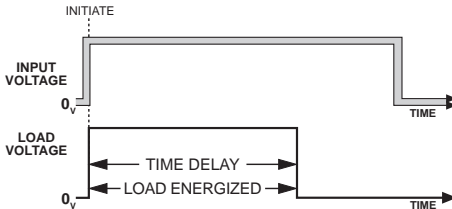

## Connection Diagrams

Single Pole Output  
1 FORM C

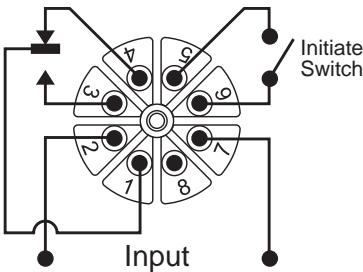

Double Pole Output  
2 FORM C

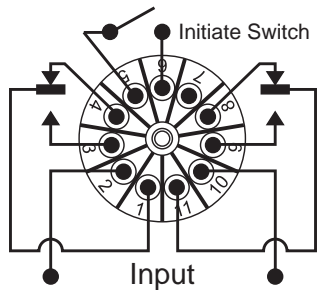

Mode Switch,  
Single Shot  
(See programming  
instructions on P.6)



# Programming for Single Time Delays

(DOM, DOB, Interval, and Single Shot)

## Setting the Mode of Operation

Mode of Operation	A	B	C
DELAY ON MAKE	OFF	OFF	OFF
DELAY ON BREAK	OFF	OFF	ON
INTERVAL	OFF	ON	OFF
SINGLE SHOT	OFF	ON	ON
DOM-DOB	<i>See Page 10</i>		
REPEAT CYCLE			

## Selectable Time Ranges

- Timing range multipliers x0.1, x1, x10, or x100
- Timing in Minutes or Seconds  
*(The example shown is set for “seconds” and the multiplier is x1).*

## Timing Adjustment

- The time delay is adjusted by closing any combination of 10 binary code switches
- Transfer a switch to the ON position then add all the ON switch values for the total time delay.  
*(The example shown is set for 171 seconds).*



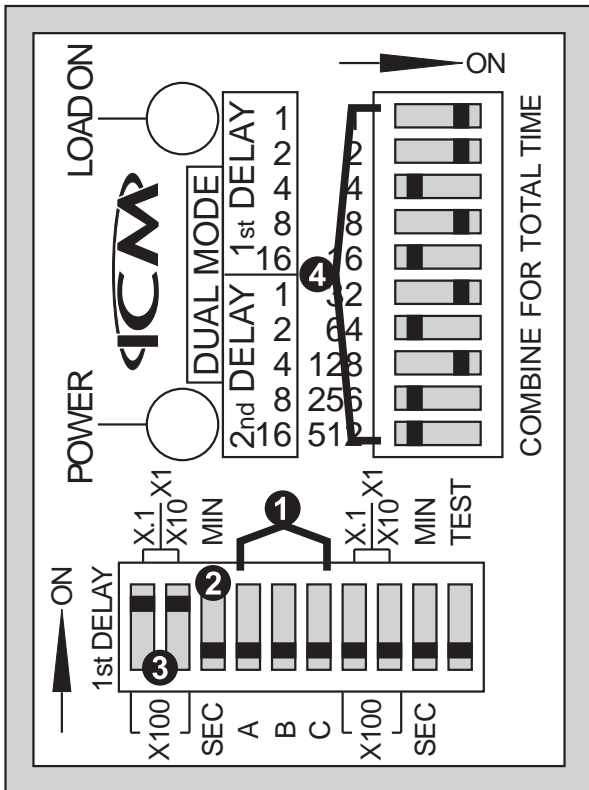

The example shown is set for Delay on Make/Delay on Break.

**Step 1:** Set the Mode of Operation

(Single and dual modes are selected by transferring a combination of three mode switches).

**Step 2:** Select Minutes or Seconds

**Step 3:** Select the Multiplier

**Step 4:** Set the Time Delay

# Delay on Make/Delay on Break

## Mode of Operation

Power must be applied at all times. Upon closure of the initiate switch, the delay on make period begins. Once complete, the contacts transfer and remain transferred as long as the initiate switch is closed. When the initiate switch opens, the delay on break period begins.

Once complete, the contacts return to their original state and all time delays reset. If the initiate contact re-closes during the delay on break period, the contacts remain transferred and the delay on break is reset.

Removal of input power resets all timing functions.

Should the initiate contact open during the delay on make period, the delay on make period is reset to zero.

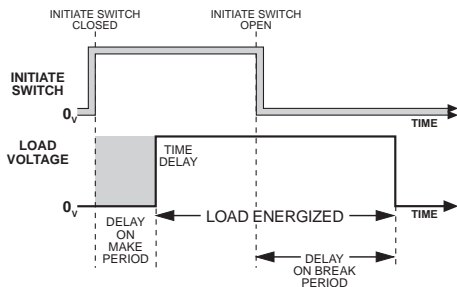

## Connection Diagrams

Single Pole Output  
1 FORM C

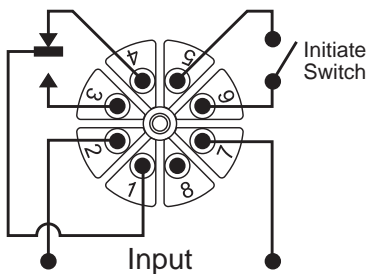

Double Pole Output  
2 FORM C

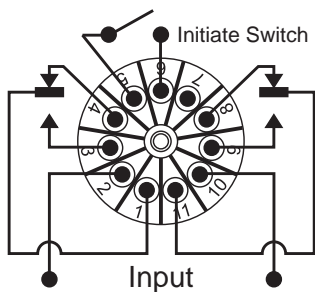

Mode Switch,  
DOM/DOB  
(See programming  
instructions on P.10)



# Repeat Cycle

## Mode of Operation

The output contacts transfer immediately when power is applied to the input terminals, initiating the ON delay. Upon completion of the ON delay, the relay transfers and the OFF delay is initiated. Maintained power application allows the unit to recycle indefinitely.

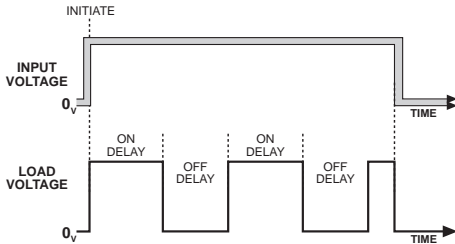

## Connection Diagrams

Single Pole Output  
1 FORM C

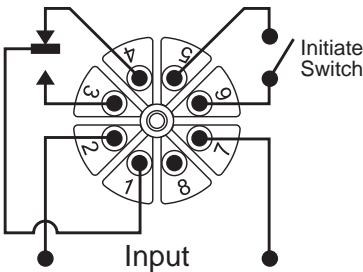

Double Pole Output  
2 FORM C

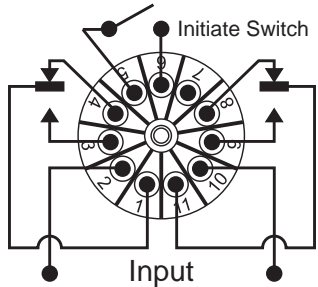

Mode Switch,  
Repeat Cycle  
(See programming  
instructions on P.10)



# Programming for Dual Time Delays

(DOM/DOB, Repeat Cycle)

## Setting the Mode of Operation

Mode of Operation	A	B	C
DELAY ON MAKE	<i>See Page 6</i>		
DELAY ON BREAK			
INTERVAL			
SINGLE SHOT			
DOM-DOB	ON	OFF	OFF
REPEAT CYCLE	ON	OFF	ON

## Selectable Time Ranges

- Timing range multipliers x0.1, x1, x10, or x100
- Timing in Minutes or Seconds

*(In the example shown, the first time delay is set for “seconds” and the multiplier is x1).*

*(The second time delay is set for “minutes”, and the multiplier is x10).*

## Timing Adjustment

- Each time delay is adjusted by closing any combination of five binary coded switches.
- Transfer a switch to the ON position then add all the ON switch values for the total time delay.

*(In the example shown, the first time is set for 11 seconds, the second for 50 minutes).*

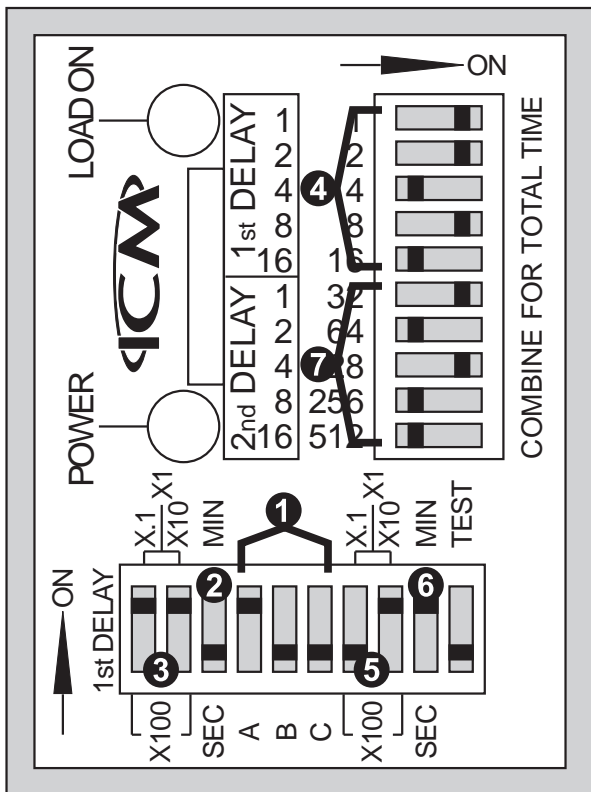

The example shown is set for Delay on Make/Delay on Break.

**Step 1:** Set the Mode of Operation

**Step 2:** Select Minutes or Seconds, First Time Delay

**Step 3:** Select the Multiplier, First Time Delay

**Step 4:** Set the First Time Delay

**Step 5:** Select the Multiplier, Second Time Delay

**Step 6:** Select Minutes or Seconds, Second Time Delay

**Step 7:** Set the Second Time Delay

# Testing the Unit

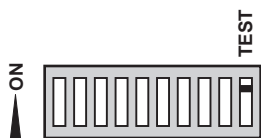

The test mode switch allows the user to test the electrical connections without changing the time delay settings. When the test mode switch is placed in the ON position, the contacts immediately transfer and remain transferred until the switch is turned OFF again. (Don't forget to turn it off.)

## Ordering Information

ICM Series	Input Voltage	Output Type	Description
ICM500	24 VAC	Single Pole, 1 FORM C 8-pin	<ul style="list-style-type: none"><li>• Multi-mode; DOM, DOB, Interval, Single Shot, DOM/DOB and Repeat Cycle</li><li>• Crystal Accuracy</li><li>• Switch Settable Delays from 1 to 1,023 seconds in multiples of 0.1, 1, 10, and 100 seconds</li><li>• Base to be ordered separately as an accessory item<ul style="list-style-type: none"><li>• For 8-pin order ASC-8</li><li>• For 11-pin order ASC-11</li></ul></li></ul>
ICM501	115 VAC		
ICM502	230 VAC		
ICM503	12 VDC		
ICM504	24 VDC		
ICM505	110 VDC		
<b>Note:</b> For 11-pin base model, Double Pole, 2 FORM C, add suffix D <b>Example:</b> ICM501D = 115 VAC, 11-pin			

# Specifications

---

## ELECTRICAL SPECIFICATIONS

### Time Delay

- Type: Switch Settable
- Range: 1-1,023 seconds or minutes
  - Multiples of 0.1, 1, 10, 100
- Repeat Accuracy:
  - $\pm 2\%$  under fixed conditions
- Fixed Time Tolerance:  $\pm 5\%$
- Time Delay vs. Temp. and Voltage:
  - $\pm 5\%$  Maximum over the specified range of input voltage and temperature.

### Reset Time

- During and after timing:
  - 75 milliseconds (May be reset during the timing period without false output)

### Input

- Nominal Voltage: 24, 115, 230 VAC  
12, 24, 110 VDC
- Tolerance:  $\pm 15\%$  of nominal
- Frequency: 50/60 Hz
- Maximum allowable DC ripple voltage: 20% peak to peak
- Power Consumption:
  - During time: 0.5 watts max.
  - After timing: 2.0 watts max.

### Output

- Type: Relay
- Form: SPDT, DPDT
- Rating: 10 amps resistive at 230 VAC
  - 1/6 HP @ 115 VAC
  - 1/3 HP @ 230 VAC
- Life: Mechanical 10,000,000;
  - Full load: 1,000,000 operations

### Protection

- Transient:  $\pm 1,400$  volts for 100 microseconds
- Polarity: DC units are inverse voltage protected
- Dielectric Breakdown:
  - 1,500 volts RMS minimum at 60 Hz between input and output terminals
- Insulation Resistance:
  - 100 megohms minimum

## MECHANICAL SPECIFICATIONS

- Mounting: Plug-in
- Termination: Standard 8 pin (octal) or 11-pin plug-in
- Weight: 5 ounces (142 grams)

## ENVIRONMENTAL SPECIFICATIONS

- Operating Temp:  $-40^{\circ}$  C to  $+85^{\circ}$  C
- Storage Temp:  $-40^{\circ}$  C to  $+85^{\circ}$  C

# NOTES

---



6333 Daedalus Drive  
Cicero, New York 13039  
(Toll Free) 800-365-5525  
(P) 315-233-5266 (F) 315-233-5276